



hanit® BASE PLATE

For dome shaped bollard (ø 20 cm)

This base plate was specially developed for the ø 20 cm dome shaped bollards. It provides a solid base on the ground and also prevents grass and weed growth around the bottom of the bollard. Easy mowing, looks great and works perfectly.

Material:

hanit® Recycled Plastic

Diameter:

50 cm

Hole diameter:

20 cm

Thickness:

3 cm

Advantages:

Prevents vegetation

Eases mowing

Rot-free

Highly rigid

100 % recyclable

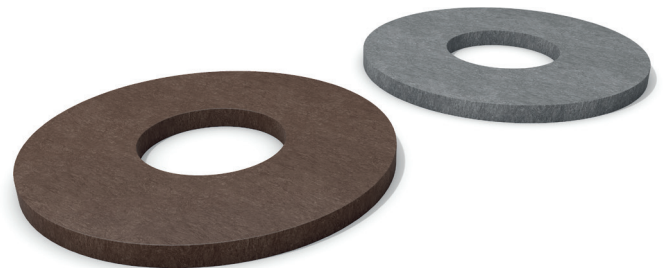

Grey

Brown



www.blauer-engel.de/uz30a

**MADE IN
GERMANY**

HAHN
KUNSTSTOFFE

DRAWING

The base plate was especially developed for the dome shaped bollard with a diameter of 20 cm.

TECHNICAL DATA

ø 50.0 cm, Hole: ø 20.0 cm

| Colour | Thickness (cm) | Weight (approx. kg) | Order No | Qty/Pal | Weight/Pal (approx. kg) | Dimensions/Pal (cm) |
|---------|----------------|---------------------|-----------|---------|-------------------------|---------------------|
| ■ Grey | 3.0 | 4.5 | BG 50 003 | 80 | 385 | 120 x 100 x 75 |
| ■ Brown | 3.0 | 4.5 | BB 50 003 | 80 | 385 | 120 x 100 x 75 |

Packaging units are intended for information only. There are no order requirements.

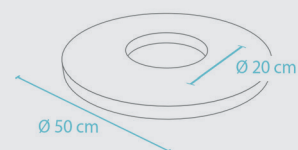

FURTHER DOCUMENTS PLEASE SEE WWW.HANIT.DE

- » General Material Remarks
- » Tender Specifications
- » General Processing Guidelines

HAHN
KUNSTSTOFFE

HAHN Kunststoffe GmbH, Gebäude 1027, DE 55483 Hahn-Flughafen

+49 (0) 65 43 / 98 86-0 +49 (0) 65 43 / 98 86-99 ✉ export@hahnkunststoffe.de 🌐 www.hanit.de



hanit® BOLLARD, DOME SHAPED

Ø 20 cm Hollow profile, with and without reflectors

This larger version of the dome shaped bollard looks particularly imposing, especially in grey due to its concrete-like appearance. Whatever the colour, the message is clear: "Keep your distance".

Material:

hanit® Recycled Plastic

Height:

120 or 150 cm

Please consider the installation depth of approx. 50 cm

Model:

Hollow profile Ø 20 cm

Deliverable with (red and white) or without reflecting bands

Advantages:

- Reflector bands are retrofittable
- Maximum protection effect
- Molded as one piece
- Rot-free
- Low weight due to hollow profile
- Simple handling
- Splinter-free
- No maintenance costs



■ Grey ■ Brown



www.blauer-engel.de/uz30a

MADE IN GERMANY

HAHN
KUNSTSTOFFE

DRAWING

The bollards are available with and without reflector strips. Only the bollards with the reflector strips have a milled cut.

Strip at top: 1.5 cm, red
 Strip at bottom: 1.5 cm, white

Palisades and bollards can be retrofitted with reflector strips or individual reflectors.

TECHNICAL DATA

| Ø 20.0 cm, including 2 reflector strips | | | | | | |
|---|-------------|---------------------|------------|---------|-------------------------|---------------------|
| Colour | Height (cm) | Weight (approx. kg) | Order No | Qty/Pal | Weight/Pal (approx. kg) | Dimensions/Pal (cm) |
| ■ Grey | 120.0 | 18.5 | PG 20120 A | 16 | 321 | 120 x 80 x 100 |
| ■ Grey | 150.0 | 23.2 | PG 20150 A | 16 | 398 | 150 x 80 x 100 |
| ■ Brown | 120.0 | 18.5 | PB 20120 A | 16 | 321 | 120 x 80 x 100 |
| ■ Brown | 150.0 | 23.2 | PB 20150 A | 16 | 398 | 150 x 80 x 100 |

| Ø 20.0 cm, excluding reflector strips | | | | | | |
|---------------------------------------|-------------|---------------------|-----------|---------|-------------------------|---------------------|
| Colour | Height (cm) | Weight (approx. kg) | Order No | Qty/Pal | Weight/Pal (approx. kg) | Dimensions/Pal (cm) |
| ■ Grey | 120.0 | 18.5 | PG 20 120 | 16 | 321 | 120 x 80 x 100 |
| ■ Grey | 150.0 | 23.3 | PG 20 150 | 16 | 398 | 150 x 80 x 100 |
| ■ Brown | 120.0 | 18.5 | PB 20 120 | 16 | 321 | 120 x 80 x 100 |
| ■ Brown | 150.0 | 23.3 | PB 20 150 | 16 | 398 | 150 x 80 x 100 |

Packaging units are intended for information only. There are no order requirements.

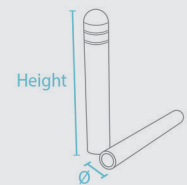

FURTHER DOCUMENTS PLEASE SEE WWW.HANIT.DE

- » General Material Remarks
- » Tender Specifications
- » General Processing Guidelines





hanit® BOLLARD, DOME SHAPED

Ø 15 cm Hollow profile, with and without reflectors

The solid-looking, round-headed design gives this hanit® bollard a smart but regulating appearance. Great for anything from quiet country parks to pulsing city centres.

Material:

hanit® Recycled Plastics

Height:

150 cm

Please consider the installation depth of approx. 50 cm

Model:

Hollow profile Ø 15 cm

Deliverable with (red and white) or without reflector bands

Advantages:

- Reflector bands are retrofittable
- Rot-free
- Low weight due to hollow profile
- Easy handling
- Splinter-free
- No maintenance costs



■ Grey ■ Brown

DBLHKP15DEEN0519



HAHN
KUNSTSTOFFE

DRAWING

The bollards are available with and without reflector strips. Only the bollards with the reflector strips have a milled cut.

Strip at top: 1.5 cm, red
 Strip at bottom: 1.5 cm, white

Palisades and bollards can be retrofitted with reflector strips or individual reflectors.

TECHNICAL DATA

| Ø 15.0 cm, excluding reflector strips | | | | | | |
|---------------------------------------|-------------|---------------------|------------|---------|-------------------------|---------------------|
| Colour | Height (cm) | Weight (approx. kg) | Order No | Qty/Pal | Weight/Pal (approx. kg) | Dimensions/Pal (cm) |
| ■ Grey | 150.0 | 14.0 | PGH 15 150 | 30 | 445 | 150 x 80 x 110 |
| ■ Brown | 150.0 | 14.0 | PBH 15 150 | 30 | 445 | 150 x 80 x 110 |

| Ø 15.0 cm, including 2 reflector strips | | | | | | |
|---|-------------|---------------------|-------------|---------|-------------------------|---------------------|
| Colour | Height (cm) | Weight (approx. kg) | Order No | Qty/Pal | Weight/Pal (approx. kg) | Dimensions/Pal (cm) |
| ■ Grey | 150.0 | 14.0 | PGH 15150 A | 30 | 445 | 150 x 80 x 110 |
| ■ Brown | 150.0 | 14.0 | PBH 15150 A | 30 | 445 | 150 x 80 x 110 |

Packaging units are intended for information only. There are no order requirements.

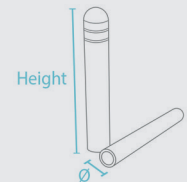

FURTHER DOCUMENTS PLEASE SEE WWW.HANIT.DE

- » General Material Remarks
- » Tender Specifications
- » General Processing Guidelines





hanit® CROSS-PROFILE STAKE

The long-lasting choice

The permanent fence post that can last a lifetime! It doesn't rot or weather and it's also UV-resistant. If you're used to wooden posts, you can work with hanit®. No specialised tools required! Fast and easy one time installation that will last and last and last.

Material:

hanit® Recycled Plastic

Dimensions:

7 x 7 cm

Various lengths available

Advantages:

- Rot-free
- Water-neutral
- Moisture-resistant
- Maintenance-free
- Long service life
- Workable like wood



■ Grey ■ Brown

DBLKRPEEN0519



HAHN
KUNSTSTOFFE

TECHNICAL DATA

7.0 x 7.0 cm

| Colour | Length (cm) | Weight (approx. kg) | Order No | Qty/Pal | Weight/Pal (approx. kg) | Dimensions/Pal (cm) |
|---------|-------------|---------------------|------------|---------|-------------------------|---------------------|
| ■ Grey | 150.0 | 2.8 | KG 070 150 | 120 | 361 | 150 x 80 x 60 |
| ■ Grey | 175.0 | 3.3 | KG 070 175 | 120 | 421 | 175 x 80 x 60 |
| ■ Grey | 200.0 | 3.7 | KG 070 200 | 120 | 469 | 200 x 80 x 60 |
| ■ Grey | 240.0 | 4.5 | KG 070 240 | 120 | 590 | 240 x 80 x 60 |
| ■ Brown | 150.0 | 2.8 | KB 070 150 | 120 | 361 | 150 x 80 x 60 |
| ■ Brown | 175.0 | 3.3 | KB 070 175 | 120 | 421 | 175 x 80 x 60 |
| ■ Brown | 200.0 | 3.7 | KB 070 200 | 120 | 469 | 200 x 80 x 60 |
| ■ Brown | 240.0 | 4.5 | KB 070 240 | 120 | 590 | 240 x 80 x 60 |

Packaging units are intended for information only. There are no order requirements. Products exceeding 200 cm in length, are packed on double pallets.

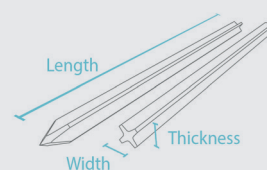

FURTHER DOCUMENTS PLEASE SEE WWW.HANIT.DE

- » Installation Recommendation
- » General Material Remarks
- » Tender Specifications
- » General Processing Guidelines

HAHN
KUNSTSTOFFE

HAHN Kunststoffe GmbH, Gebäude 1027, DE 55483 Hahn-Flughafen

+49 (0) 65 43 / 98 86-0 +49 (0) 65 43 / 98 86-99 ✉ export@hahnkunststoffe.de 🌐 www.hanit.de



hanit® DIAMOND HEAD BOLLARD

Hollow profile, with and without reflectors

hanit® bollards are an effective way to direct and control traffic. They send a clear message and can prevent cars from parking on pavements or blocking cycle lanes. The diamond head bollard is particularly useful in urban settings.

Material:

hanit® Recycled Plastic

Height:

140 cm

Profile diameter:

14 x 14 cm

Model:

Hollow profile
Deliverable with or without reflector bands

Advantages:

- Rot-free and rigid
- Splinter-free
- Hollow profile = low weight
- Simple to process
- No maintenance costs
- Sunk reflector bands = decreased break-off risk
- High attention value
- Made without harmful impregnation agents
- 100 % recyclable

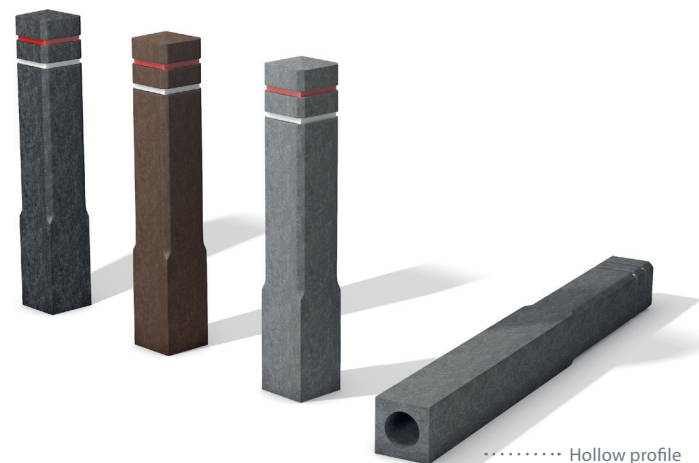

Grey Brown Black

DBLDKPDEN0519



DRAWING

The bollards are available with and without reflector strips. Only the bollards with the reflector strips have a milled cut.

Strip at top: 1.5 cm, red
 Strip at bottom: 1.5 cm, white

Palisades and bollards can be retrofitted with reflector strips or individual reflectors.

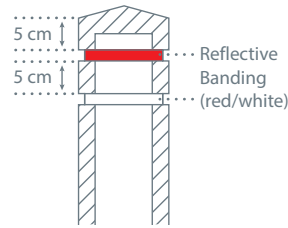

TECHNICAL DATA

| 14.0 x 14.0 cm, with 2 reflector strips | | | | | | |
|---|-------------|---------------------|--------------|---------|---------------------|---------------------|
| Colour | Height (cm) | Weight (approx. kg) | Order No | Qty/Pal | Weight/Pal (ca. kg) | Dimensions/Pal (cm) |
| ■ Grey | 140.0 | 17.0 | PDHG 14140 A | 48 | 841 | 140 x 85 x 130 |
| ■ Brown | 140.0 | 17.0 | PDHB 14140 A | 48 | 841 | 140 x 85 x 130 |
| ■ Black | 140.0 | 17.0 | PDH 14140 A | 48 | 841 | 140 x 85 x 130 |

| 14.0 x 14.0 cm, without reflector strips | | | | | | |
|--|-------------|---------------------|-------------|---------|---------------------|---------------------|
| Colour | Height (cm) | Weight (approx. kg) | Order No | Qty/Pal | Weight/Pal (ca. kg) | Dimensions/Pal (cm) |
| ■ Grey | 140.0 | 17.0 | PDHG 14 140 | 48 | 841 | 140 x 85 x 130 |
| ■ Brown | 140.0 | 17.0 | PDHB 14 140 | 48 | 841 | 140 x 85 x 130 |
| ■ Black | 140.0 | 17.0 | PDH 14 140 | 48 | 841 | 140 x 85 x 130 |

Packaging units are intended for information only. There are no order requirements.

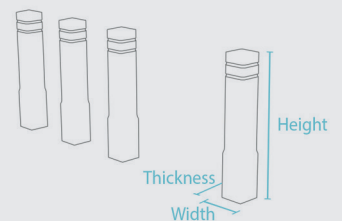

FURTHER DOCUMENTS PLEASE SEE WWW.HANIT.DE





hanit® PALE AND POST

With rounded head

hanit® fence boards and fence posts are impervious to the influence of weather and soil contact. The posts can be set directly into the ground. Pales made of recycled plastic can also be used for repairs, provided an existing support structure is still intact. Our fence boards and posts are delivered with rounded off heads as standard.

Material:

hanit® Recycled Plastic

Model:

Fence boards and posts delivered with rounded off heads

Various lengths, diameters and colours

Diameter pales:

2 x 6 cm and 3 x 10 cm

Diameter posts:

9 x 9 cm

Advantages:

Maintenance-free - no more painting

Weather-proof

No harmful impregnating agents used

Individual fencing design

Note:

When using hanit® posts, the fence panels have to be mounted in between the posts

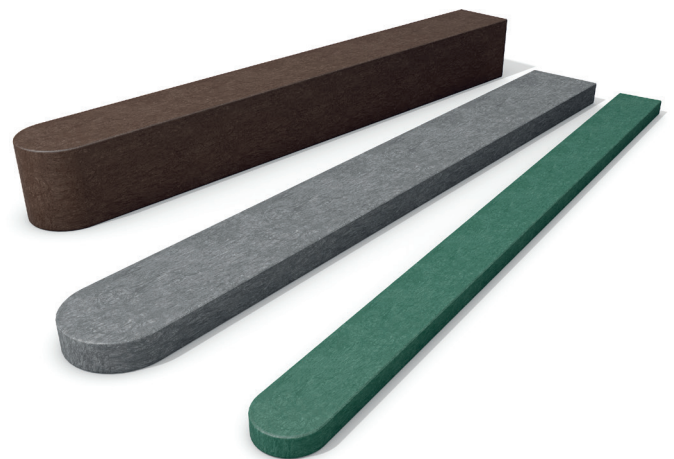

Grey Brown Green

DBLZALDEEN0519



TECHNICAL DATA

2.0 x 6.0 cm

| Colour | Height (cm) | Weight (approx. kg) | Order No | Qty/Pal |
|---------|-------------|---------------------|-------------|---------|
| ■ Grey | 60.0 | 0.7 | ZG 2006 060 | 460 |
| ■ Grey | 80.0 | 0.9 | ZG 2006 080 | 400 |
| ■ Grey | 100.0 | 1.1 | ZG 2006 100 | 400 |
| ■ Grey | 120.0 | 1.3 | ZG 2006 120 | 230 |
| ■ Grey | 150.0 | 1.7 | ZG 2006 150 | 260 |
| ■ Brown | 60.0 | 0.7 | ZB 2006 060 | 460 |
| ■ Brown | 80.0 | 0.9 | ZB 2006 080 | 400 |
| ■ Brown | 100.0 | 1.1 | ZB 2006 100 | 400 |
| ■ Brown | 120.0 | 1.3 | ZB 2006 120 | 230 |
| ■ Brown | 150.0 | 1.7 | ZB 2006 150 | 260 |
| ■ Green | 60.0 | 0.7 | ZM 2006 060 | 460 |
| ■ Green | 80.0 | 0.9 | ZM 2006 080 | 400 |
| ■ Green | 100.0 | 1.1 | ZM 2006 100 | 400 |
| ■ Green | 120.0 | 1.3 | ZM 2006 120 | 230 |
| ■ Green | 150.0 | 1.7 | ZM 2006 150 | 260 |

3.0 x 10.0 cm

| Colour | Height (cm) | Weight (approx. kg) | Order No | Qty/Pal |
|---------|-------------|---------------------|-------------|---------|
| ■ Grey | 60.0 | 1.7 | ZG 3010 060 | 320 |
| ■ Grey | 80.0 | 2.2 | ZG 3010 080 | 240 |
| ■ Grey | 100.0 | 2.8 | ZG 3010 100 | 240 |
| ■ Grey | 120.0 | 3.3 | ZG 3010 120 | 160 |
| ■ Grey | 150.0 | 4.2 | ZG 3010 150 | 160 |
| ■ Brown | 60.0 | 1.7 | ZB 3010 060 | 320 |
| ■ Brown | 80.0 | 2.2 | ZB 3010 080 | 240 |
| ■ Brown | 100.0 | 2.8 | ZB 3010 100 | 240 |
| ■ Brown | 120.0 | 3.3 | ZB 3010 120 | 160 |
| ■ Brown | 150.0 | 4.2 | ZB 3010 150 | 160 |
| ■ Green | 60.0 | 1.7 | ZM 3010 060 | 320 |
| ■ Green | 80.0 | 2.2 | ZM 3010 080 | 240 |
| ■ Green | 100.0 | 2.8 | ZM 3010 100 | 240 |
| ■ Green | 120.0 | 3.3 | ZM 3010 120 | 160 |
| ■ Green | 150.0 | 4.2 | ZM 3010 150 | 160 |

9.0 x 9.0 cm

| Colour | Height (cm) | Weight (approx. kg) | Order No | Qty/Pal |
|---------|-------------|---------------------|-------------|---------|
| ■ Grey | 75.0 | 5.6 | ZG 0909 075 | 130 |
| ■ Grey | 100.0 | 7.5 | ZG 0909 100 | 130 |
| ■ Grey | 125.0 | 9.4 | ZG 0909 125 | 90 |
| ■ Grey | 150.0 | 11.3 | ZG 0909 150 | 90 |
| ■ Grey | 175.0 | 13.2 | ZG 0909 175 | 90 |
| ■ Grey | 200.0 | 15.0 | ZG 0909 200 | 90 |
| ■ Brown | 75.0 | 5.6 | ZB 0909 075 | 130 |
| ■ Brown | 100.0 | 7.5 | ZB 0909 100 | 130 |
| ■ Brown | 125.0 | 9.4 | ZB 0909 125 | 90 |
| ■ Brown | 150.0 | 11.3 | ZB 0909 150 | 90 |
| ■ Brown | 175.0 | 13.2 | ZB 0909 175 | 90 |
| ■ Brown | 200.0 | 15.0 | ZB 0909 200 | 90 |
| ■ Green | 75.0 | 5.6 | ZM 0909 075 | 130 |
| ■ Green | 100.0 | 7.5 | ZM 0909 100 | 130 |
| ■ Green | 125.0 | 9.4 | ZM 0909 125 | 90 |
| ■ Green | 150.0 | 11.3 | ZM 0909 150 | 90 |
| ■ Green | 175.0 | 13.2 | ZM 0909 175 | 90 |
| ■ Green | 200.0 | 15.0 | ZM 0909 200 | 90 |

Caution: Plastic profiles are only marginally suitable as cross-bars. We are happy to advise you.

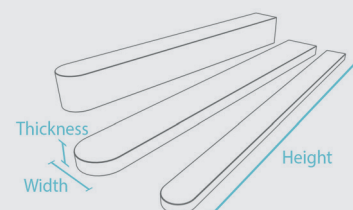

FURTHER DOCUMENTS PLEASE SEE WWW.HANIT.DE

- » General Material Remarks
- » General Processing Guidelines





hanit® PYRAMID HEAD BOLLARD

Hollow profile, with reflectors

Due to the unusual head shape, our pyramid head bollards draw attention in almost any setting. They do exactly what they're supposed to do: keep spaces clear.

Material:

hanit® Recycled Plastic

Height:

165 cm

Please consider the installation depth of approx. 50 cm

Profile diameter:

12 x 12 cm

Model:

Two round reflectors Ø 6 cm

Opposite side rectangular reflector 4 x 18 cm

Advantages:

Distinctive design

Effective protection

Durable and rot-free

Splinter-free

Hollow profile = low weight

Simple processing

No maintenance costs

Sunk reflector bands = decreased break-off risk

High attention value

Made without harmful impregnation agents

100 % recyclable

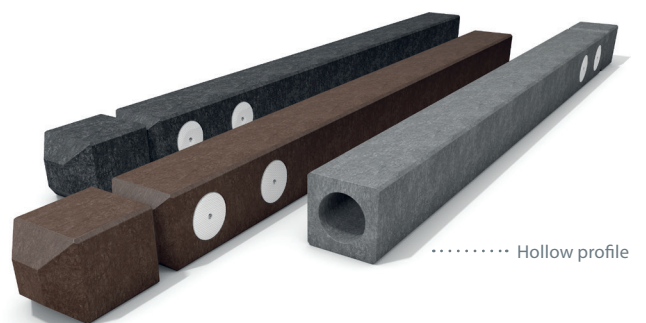

Grey
 Brown
 Black

DBLPKPEEN0519



HAHN
KUNSTSTOFFE

DRAWING

The bollard is equipped with two round reflectors (ø 6 cm) and a rectangular reflector (4 x 18 cm).

TECHNICAL DATA

12.0 x 12.0 cm, including reflectors

| Colour | Height (cm) | Weight (approx. kg) | Order No | Qty/Pal | Weight/Pal (approx. kg) | Dimensions/Pal (cm) |
|---------|-------------|---------------------|---------------|---------|-------------------------|---------------------|
| ■ Grey | 160.0 | 13.9 | PGA 1212160 A | 49 | 706 | 160 x 85 x 110 |
| ■ Brown | 160.0 | 13.9 | PBA 1212160 A | 49 | 706 | 160 x 85 x 110 |
| ■ Black | 160.0 | 13.9 | PSA 1212160 A | 49 | 706 | 160 x 85 x 110 |

Packaging units are intended for information only. There are no order requirements.

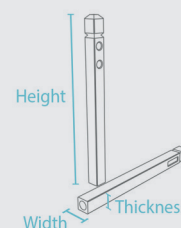

FURTHER DOCUMENTS PLEASE SEE WWW.HANIT.DE

- » General Material Remarks
- » Tender Specifications
- » General Processing Guidelines

HAHN
KUNSTSTOFFE



hanit® ROUND POST

When it needs to last.

Building a fence is easily achievable with hanit® posts. There will no longer be a problem with horses chewing on paddock or pasture fencing. There is also no need to worry about any danger of injuries due to splinters or health hazards caused by preservatives. Instead, the posts are weather-resistant, can not rot, and are extremely durable.

Material:

hanit® Recycled Plastic

Version:

Many lengths and diameters available
Solid material with point

Advantages:

- Lasts longer than wood
- Splinter-free
- Rot-free
- Without harmful impregnating agents
- Flexible use
- Simple to install



■ Grey ■ Brown

DBLRP5DEEN0619



TECHNICAL DATA

Ø 4.5 cm

| Colour | Length (cm) | Weight (approx. kg) | Order No | Qty/Pal | Weight/Pal (approx. kg) | Dimensions/Pal (cm) |
|---------|-------------|---------------------|------------|---------|-------------------------|---------------------|
| ■ Grey | 85.0 | 1.3 | SG 045 085 | 300 | 415 | 120 x 80 x 90 |
| ■ Grey | 100.0 | 1.5 | SG 045 100 | 300 | 475 | 120 x 80 x 90 |
| ■ Grey | 130.0 | 1.9 | SG 045 130 | 165 | 339 | 130 x 80 x 60 |
| ■ Grey | 150.0 | 2.2 | SG 045 150 | 165 | 388 | 150 x 80 x 60 |
| ■ Grey | 175.0 | 2.6 | SG 045 175 | 165 | 454 | 175 x 80 x 60 |
| ■ Brown | 85.0 | 1.3 | SB 045 085 | 300 | 415 | 120 x 80 x 90 |
| ■ Brown | 100.0 | 1.5 | SB 045 100 | 300 | 475 | 120 x 80 x 90 |
| ■ Brown | 130.0 | 1.9 | SB 045 130 | 165 | 339 | 130 x 80 x 60 |
| ■ Brown | 150.0 | 2.2 | SB 045 150 | 165 | 388 | 150 x 80 x 60 |
| ■ Brown | 175.0 | 2.6 | SB 045 175 | 165 | 454 | 175 x 80 x 60 |

Ø 6.0 cm

| Colour | Length (cm) | Weight (approx. kg) | Order No | Qty/Pal | Weight/Pal (approx. kg) | Dimensions/Pal (cm) |
|---------|-------------|---------------------|------------|---------|-------------------------|---------------------|
| ■ Grey | 150.0 | 3.9 | SG 060 150 | 125 | 513 | 150 x 80 x 70 |
| ■ Grey | 175.0 | 4.6 | SG 060 175 | 125 | 600 | 175 x 80 x 70 |
| ■ Grey | 200.0 | 5.3 | SG 060 200 | 125 | 688 | 200 x 80 x 70 |
| ■ Grey | 225.0 | 5.9 | SG 060 225 | 125 | 788 | 240 x 80 x 70 |
| ■ Grey | 250.0 | 6.6 | SG 060 250 | 125 | 875 | 250 x 80 x 70 |
| ■ Brown | 150.0 | 3.9 | SB 060 150 | 125 | 513 | 150 x 80 x 70 |
| ■ Brown | 175.0 | 4.6 | SB 060 175 | 125 | 600 | 175 x 80 x 70 |
| ■ Brown | 200.0 | 5.3 | SB 060 200 | 125 | 688 | 200 x 80 x 70 |
| ■ Brown | 225.0 | 5.9 | SB 060 225 | 125 | 788 | 240 x 80 x 70 |
| ■ Brown | 250.0 | 6.6 | SB 060 250 | 125 | 875 | 250 x 80 x 70 |

Ø 7.0 cm

| Colour | Length (cm) | Weight (approx. kg) | Order No | Qty/Pal | Weight/Pal (approx. kg) | Dimensions/Pal (cm) |
|---------|-------------|---------------------|------------|---------|-------------------------|---------------------|
| ■ Grey | 150.0 | 5.4 | SG 070 150 | 74 | 425 | 150 x 80 x 65 |
| ■ Grey | 175.0 | 6.3 | SG 070 175 | 74 | 492 | 175 x 80 x 65 |
| ■ Grey | 200.0 | 7.2 | SG 070 200 | 74 | 558 | 200 x 80 x 65 |
| ■ Grey | 225.0 | 8.1 | SG 070 225 | 74 | 650 | 240 x 80 x 65 |
| ■ Grey | 250.0 | 9.0 | SG 070 250 | 74 | 716 | 250 x 80 x 65 |
| ■ Brown | 150.0 | 5.4 | SB 070 150 | 74 | 425 | 150 x 80 x 65 |
| ■ Brown | 175.0 | 6.3 | SB 070 175 | 74 | 492 | 175 x 80 x 65 |
| ■ Brown | 200.0 | 7.2 | SB 070 200 | 74 | 558 | 200 x 80 x 65 |
| ■ Brown | 225.0 | 8.1 | SB 070 225 | 74 | 650 | 240 x 80 x 65 |
| ■ Brown | 250.0 | 9.0 | SB 070 250 | 74 | 716 | 250 x 80 x 65 |

» Continued on next page

HAHN
KUNSTSTOFFE

| Ø 8.0 cm | | | | | | |
|----------|-------------|---------------------|------------|---------|-------------------------|---------------------|
| Colour | Length (cm) | Weight (approx. kg) | Order No | Qty/Pal | Weight/Pal (approx. kg) | Dimensions/Pal (cm) |
| ■ Grey | 50.0 | 2.3 | SG 080 050 | 120 | 301 | 120 x 80 x 65 |
| ■ Grey | 75.0 | 3.5 | SG 080 075 | 95 | 358 | 120 x 80 x 65 |
| ■ Grey | 100.0 | 4.7 | SG 080 100 | 95 | 472 | 120 x 100 x 65 |
| ■ Grey | 125.0 | 5.8 | SG 080 125 | 60 | 373 | 125 x 80 x 65 |
| ■ Grey | 150.0 | 7.0 | SG 080 150 | 60 | 445 | 150 x 80 x 65 |
| ■ Grey | 175.0 | 8.2 | SG 080 175 | 60 | 517 | 175 x 80 x 65 |
| ■ Grey | 200.0 | 9.3 | SG 080 200 | 60 | 583 | 200 x 80 x 65 |
| ■ Grey | 225.0 | 10.5 | SG 080 225 | 60 | 680 | 240 x 80 x 65 |
| ■ Grey | 250.0 | 11.7 | SG 080 250 | 60 | 752 | 250 x 80 x 65 |
| ■ Grey | 280.0 | 13.1 | SG 080 280 | 60 | 836 | 280 x 80 x 65 |
| ■ Brown | 50.0 | 2.3 | SB 080 050 | 120 | 301 | 120 x 80 x 65 |
| ■ Brown | 75.0 | 3.5 | SB 080 075 | 95 | 358 | 120 x 80 x 65 |
| ■ Brown | 100.0 | 4.7 | SB 080 100 | 95 | 472 | 120 x 100 x 65 |
| ■ Brown | 125.0 | 5.8 | SB 080 125 | 60 | 373 | 125 x 80 x 65 |
| ■ Brown | 150.0 | 7.0 | SB 080 150 | 60 | 445 | 150 x 80 x 65 |
| ■ Brown | 175.0 | 8.2 | SB 080 175 | 60 | 517 | 175 x 80 x 65 |
| ■ Brown | 200.0 | 9.3 | SB 080 200 | 60 | 583 | 200 x 80 x 65 |
| ■ Brown | 225.0 | 10.5 | SB 080 225 | 60 | 680 | 240 x 80 x 65 |
| ■ Brown | 250.0 | 11.7 | SB 080 250 | 60 | 752 | 250 x 80 x 65 |
| ■ Brown | 280.0 | 13.1 | SB 080 280 | 60 | 836 | 280 x 80 x 65 |

| Ø 10.0 cm | | | | | | |
|-----------|-------------|---------------------|------------|---------|-------------------------|---------------------|
| Colour | Length (cm) | Weight (approx. kg) | Order No | Qty/Pal | Weight/Pal (approx. kg) | Dimensions/Pal (cm) |
| ■ Grey | 50.0 | 3.7 | SG 100 050 | 66 | 269 | 120 x 80 x 60 |
| ■ Grey | 75.0 | 5.5 | SG 100 075 | 53 | 317 | 120 x 80 x 60 |
| ■ Grey | 100.0 | 7.3 | SG 100 100 | 53 | 412 | 120 x 100 x 60 |
| ■ Grey | 125.0 | 9.1 | SG 100 125 | 33 | 325 | 125 x 80 x 60 |
| ■ Grey | 150.0 | 11.0 | SG 100 150 | 33 | 388 | 150 x 80 x 60 |
| ■ Grey | 175.0 | 12.8 | SG 100 175 | 33 | 447 | 175 x 80 x 60 |
| ■ Grey | 200.0 | 14.6 | SG 100 200 | 33 | 507 | 200 x 80 x 60 |
| ■ Grey | 230.0 | 16.8 | SG 100 230 | 33 | 604 | 240 x 80 x 60 |
| ■ Grey | 250.0 | 18.3 | SG 100 250 | 33 | 654 | 250 x 80 x 60 |
| ■ Grey | 280.0 | 20.4 | SG 100 280 | 33 | 723 | 280 x 80 x 60 |
| ■ Grey | 290.0 | 21.5 | SG 100 290 | 33 | 760 | 290 x 80 x 60 |
| ■ Brown | 50.0 | 3.7 | SB 100 050 | 66 | 269 | 120 x 80 x 60 |
| ■ Brown | 75.0 | 5.5 | SB 100 075 | 53 | 317 | 120 x 80 x 60 |
| ■ Brown | 100.0 | 7.3 | SB 100 100 | 53 | 412 | 120 x 100 x 60 |
| ■ Brown | 125.0 | 9.1 | SB 100 125 | 33 | 325 | 125 x 80 x 60 |
| ■ Brown | 150.0 | 11.0 | SB 100 150 | 33 | 388 | 150 x 80 x 60 |
| ■ Brown | 175.0 | 12.8 | SB 100 175 | 33 | 447 | 175 x 80 x 60 |
| ■ Brown | 200.0 | 14.6 | SB 100 200 | 33 | 507 | 200 x 80 x 60 |
| ■ Brown | 230.0 | 16.8 | SB 100 230 | 33 | 604 | 240 x 80 x 60 |
| ■ Brown | 250.0 | 18.3 | SB 100 250 | 33 | 654 | 250 x 80 x 60 |

» Continued on next page

HAHN
KUNSTSTOFFE

| Ø 10.0 cm | | | | | | |
|-----------|-------------|---------------------|------------|---------|-------------------------|---------------------|
| Colour | Length (cm) | Weight (approx. kg) | Order No | Qty/Pal | Weight/Pal (approx. kg) | Dimensions/Pal (cm) |
| ■ Brown | 280.0 | 20.4 | SB 100 280 | 33 | 723 | 280 x 80 x 60 |
| ■ Brown | 290.0 | 21.5 | SB 100 290 | 33 | 760 | 290 x 80 x 60 |

| Ø 12.0 cm | | | | | | |
|-----------|-------------|---------------------|------------|---------|-------------------------|---------------------|
| Colour | Length (cm) | Weight (approx. kg) | Order No | Qty/Pal | Weight/Pal (approx. kg) | Dimensions/Pal (cm) |
| ■ Grey | 100.0 | 10.5 | SG 120 100 | 43 | 477 | 120 x 100 x 70 |
| ■ Grey | 125.0 | 13.1 | SG 120 125 | 28 | 392 | 125 x 80 x 70 |
| ■ Grey | 150.0 | 15.8 | SG 120 150 | 28 | 468 | 150 x 80 x 70 |
| ■ Grey | 175.0 | 18.4 | SG 120 175 | 28 | 540 | 175 x 80 x 70 |
| ■ Grey | 200.0 | 21.0 | SG 120 200 | 28 | 613 | 200 x 80 x 70 |
| ■ Grey | 225.0 | 23.7 | SG 120 225 | 28 | 714 | 240 x 80 x 70 |
| ■ Grey | 250.0 | 26.3 | SG 120 250 | 28 | 786 | 250 x 80 x 70 |
| ■ Grey | 280.0 | 29.4 | SG 120 280 | 28 | 873 | 280 x 80 x 70 |
| ■ Brown | 100.0 | 10.5 | SB 120 100 | 43 | 477 | 120 x 100 x 70 |
| ■ Brown | 125.0 | 13.1 | SB 120 125 | 28 | 392 | 125 x 80 x 70 |
| ■ Brown | 150.0 | 15.8 | SB 120 150 | 28 | 468 | 150 x 80 x 70 |
| ■ Brown | 175.0 | 18.4 | SB 120 175 | 28 | 540 | 175 x 80 x 70 |
| ■ Brown | 200.0 | 21.0 | SB 120 200 | 28 | 613 | 200 x 80 x 70 |
| ■ Brown | 225.0 | 23.7 | SB 120 225 | 28 | 714 | 240 x 80 x 70 |
| ■ Brown | 250.0 | 26.3 | SB 120 250 | 28 | 786 | 250 x 80 x 70 |
| ■ Brown | 280.0 | 29.4 | SB 120 280 | 28 | 873 | 280 x 80 x 70 |

| Ø 15.0 cm | | | | | | |
|-----------|-------------|---------------------|------------|---------|-------------------------|---------------------|
| Colour | Length (cm) | Weight (approx. kg) | Order No | Qty/Pal | Weight/Pal (approx. kg) | Dimensions/Pal (cm) |
| ■ Grey | 100.0 | 16.4 | SG 150 100 | 48 | 812 | 120 x 100 x 110 |
| ■ Grey | 125.0 | 20.6 | SG 150 125 | 30 | 643 | 125 x 80 x 110 |
| ■ Grey | 150.0 | 24.7 | SG 150 150 | 30 | 766 | 150 x 80 x 110 |
| ■ Grey | 175.0 | 28.8 | SG 150 175 | 30 | 889 | 175 x 80 x 110 |
| ■ Grey | 200.0 | 32.9 | SG 150 200 | 30 | 1012 | 200 x 80 x 110 |
| ■ Grey | 225.0 | 37.0 | SG 150 225 | 30 | 1160 | 240 x 80 x 110 |
| ■ Grey | 250.0 | 41.1 | SG 150 250 | 30 | 1283 | 250 x 80 x 110 |
| ■ Grey | 280.0 | 46.0 | SG 150 280 | 30 | 1430 | 280 x 80 x 110 |
| ■ Brown | 100.0 | 16.4 | SB 150 100 | 48 | 812 | 120 x 100 x 110 |
| ■ Brown | 125.0 | 20.6 | SB 150 125 | 30 | 643 | 125 x 80 x 110 |
| ■ Brown | 150.0 | 24.7 | SB 150 150 | 30 | 766 | 150 x 80 x 110 |
| ■ Brown | 175.0 | 28.8 | SB 150 175 | 30 | 889 | 175 x 80 x 110 |
| ■ Brown | 200.0 | 32.9 | SB 150 200 | 30 | 1012 | 200 x 80 x 110 |
| ■ Brown | 225.0 | 37.0 | SB 150 225 | 30 | 1160 | 240 x 80 x 110 |
| ■ Brown | 250.0 | 41.1 | SB 150 250 | 30 | 1283 | 250 x 80 x 110 |
| ■ Brown | 280.0 | 46.0 | SB 150 280 | 30 | 1430 | 280 x 80 x 110 |

Packaging units are intended for information only. There are no order requirements. Products exceeding 200 cm in length, are packed on double pallets.

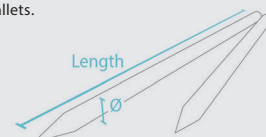

FURTHER DOCUMENTS AVAILABLE AT WWW.HANIT.DE

- » Installation Recommendation Posts
- » General Product Remarks
- » Tender Specification
- » General Processing Guidelines



HAHN Kunststoffe GmbH, Gebäude 1027, DE 55483 Hahn-Flughafen

+49 (0) 65 43/98 86-0 +49 (0) 65 43/98 86-99 export@hahnkunststoffe.de www.hanit.de



hanit® SQUARE POST

The square-edged one with profile

Contact with soil or a humid environment can have a negative effect on normal materials. But not our hanit® profiles. Extremely suitable for substructures for patios, balconies and roofs, or even in the barn area, because of its shape. Due to the wide variety of geometries, we can always supply you with the correct profile: You have the ideas, we have the solutions.

Material:

hanit® Recycled Plastic

Model:

Available in various sizes and strengths
Solid material with point

Advantages:

- More durable than wood
- Splinter-free
- Rot-free
- No harmful impregnation agents used
- Flexible use
- Easy to work
- Workable like wood

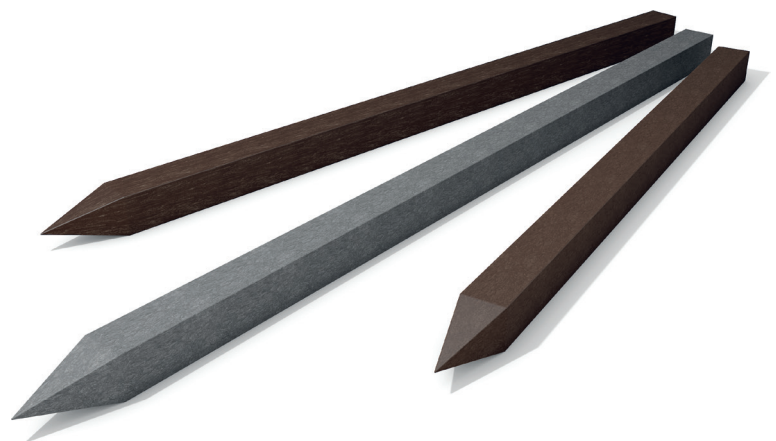
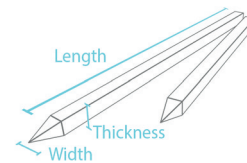

Grey Brown

DBLVPSDEEN0519



TECHNICAL DATA

5.0 x 5.0 cm

| Colour | Length (cm) | Weight (approx. kg) | Order No | Qty/Pal | Weight/Pal (approx. kg) | Dimensions/Pal (cm) |
|---------|-------------|---------------------|------------|---------|-------------------------|---------------------|
| ■ Grey | 125.0 | 2.8 | VG 050 125 | 240 | 468 | 125 x 80 x 65 |
| ■ Grey | 150.0 | 3.4 | VG 050 150 | 240 | 561 | 150 x 80 x 65 |
| ■ Brown | 125.0 | 2.8 | VB 050 125 | 240 | 468 | 125 x 80 x 65 |
| ■ Brown | 150.0 | 3.4 | VB 050 150 | 240 | 561 | 150 x 80 x 65 |

7.0 x 7.0 cm

| Colour | Length (cm) | Weight (approx. kg) | Order No | Qty/Pal | Weight/Pal (approx. kg) | Dimensions/Pal (cm) |
|---------|-------------|---------------------|------------|---------|-------------------------|---------------------|
| ■ Grey | 100.0 | 4.5 | VG 070 100 | 121 | 570 | 120 x 80 x 90 |
| ■ Grey | 125.0 | 5.7 | VG 070 125 | 55 | 339 | 125 x 80 x 60 |
| ■ Grey | 150.0 | 6.8 | VG 070 150 | 55 | 399 | 150 x 80 x 60 |
| ■ Grey | 175.0 | 8.0 | VG 070 175 | 55 | 465 | 175 x 80 x 60 |
| ■ Grey | 200.0 | 9.1 | VG 070 200 | 55 | 526 | 200 x 80 x 60 |
| ■ Grey | 225.0 | 10.2 | VG 070 225 | 55 | 611 | 240 x 80 x 60 |
| ■ Grey | 250.0 | 11.4 | VG 070 250 | 55 | 677 | 250 x 80 x 60 |
| ■ Grey | 280.0 | 12.7 | VG 070 280 | 55 | 749 | 280 x 80 x 60 |
| ■ Brown | 100.0 | 4.5 | VB 070 100 | 121 | 570 | 120 x 80 x 90 |
| ■ Brown | 125.0 | 5.7 | VB 070 125 | 55 | 339 | 125 x 80 x 60 |
| ■ Brown | 150.0 | 6.8 | VB 070 150 | 55 | 399 | 150 x 80 x 60 |
| ■ Brown | 175.0 | 8.0 | VB 070 175 | 55 | 465 | 175 x 80 x 60 |
| ■ Brown | 200.0 | 9.1 | VB 070 200 | 55 | 526 | 200 x 80 x 60 |
| ■ Brown | 225.0 | 10.2 | VB 070 225 | 55 | 611 | 240 x 80 x 60 |
| ■ Brown | 250.0 | 11.4 | VB 070 250 | 55 | 677 | 250 x 80 x 60 |
| ■ Brown | 280.0 | 12.7 | VB 070 280 | 55 | 749 | 280 x 80 x 60 |

9.0 x 9.0 cm

| Colour | Length (cm) | Weight (approx. kg) | Order No | Qty/Pal | Weight/Pal (approx. kg) | Dimensions/Pal (cm) |
|---------|-------------|---------------------|------------|---------|-------------------------|---------------------|
| ■ Grey | 100.0 | 7.5 | VG 090 100 | 130 | 1000 | 120 x 100 x 105 |
| ■ Grey | 125.0 | 9.4 | VG 090 125 | 45 | 448 | 125 x 81 x 70 |
| ■ Grey | 150.0 | 11.3 | VG 090 150 | 45 | 534 | 150 x 81 x 70 |
| ■ Grey | 175.0 | 13.2 | VG 090 175 | 45 | 619 | 175 x 81 x 70 |
| ■ Grey | 200.0 | 15.1 | VG 090 200 | 45 | 705 | 200 x 81 x 70 |
| ■ Grey | 225.0 | 16.9 | VG 090 225 | 45 | 811 | 240 x 81 x 70 |
| ■ Grey | 250.0 | 18.8 | VG 090 250 | 45 | 896 | 250 x 81 x 70 |
| ■ Grey | 280.0 | 21.1 | VG 090 280 | 45 | 1000 | 280 x 81 x 70 |
| ■ Brown | 100.0 | 7.5 | VB 090 100 | 130 | 1000 | 120 x 100 x 105 |
| ■ Brown | 125.0 | 9.4 | VB 090 125 | 45 | 448 | 125 x 81 x 70 |
| ■ Brown | 150.0 | 11.3 | VB 090 150 | 45 | 534 | 150 x 81 x 70 |
| ■ Brown | 175.0 | 13.2 | VB 090 175 | 45 | 619 | 175 x 81 x 70 |
| ■ Brown | 200.0 | 15.1 | VB 090 200 | 45 | 705 | 200 x 81 x 70 |
| ■ Brown | 225.0 | 16.9 | VB 090 225 | 45 | 811 | 240 x 81 x 70 |
| ■ Brown | 250.0 | 18.8 | VB 090 250 | 45 | 896 | 250 x 81 x 70 |
| ■ Brown | 280.0 | 21.1 | VB 090 280 | 45 | 1000 | 280 x 81 x 70 |

Packaging units are intended for information only. There are no order requirements. Products exceeding 200 cm in length, are packed on double pallets.

FURTHER DOCUMENTS PLEASE SEE WWW.HANIT.DE

- » Installation Recommendation
- » General Material Remarks
- » Tender Specifications
- » General Processing Guidelines

HAHN
KUNSTSTOFFE

HAHN Kunststoffe GmbH, Gebäude 1027, DE 55483 Hahn-Flughafen

+49 (0) 65 43/98 86-0 ☎ +49 (0) 65 43/98 86-99 ✉ export@hahnkunststoffe.de 🌐 www.hanit.de



hanit® BARRIER

Bevelled at each end

Some areas need subtle protection from unwanted footfall or traffic, without blocking the area off completely. Our barriers help steer individuals and groups towards preferred routes and keep traffic going in the right direction. Good looking, effective, long-lasting and maintenance-free. Thanks to the internal steel reinforcement the new hanit® crossbar is even more robust. It offers a sufficient and valuable barrier for many years.

Material:

hanit® Recycled Plastic

Post dimensions:

12 x 95 cm

Cross bar dimensions:

12 x 280 cm

Model:

Crossbar with internal steel reinforcement S235 (Ø 42.4 cm, wall thickness approx. 2.5 mm)

Openings will be closed with stoppers

Crossbars bevelled on both sides

Mounting holes pre-drilled and sunken

Including mounting material

Installation recommendation:

We recommend to cement the posts approx. 50 cm into the ground and 160 cm apart from each other

Advantages:

Screws in and ready

Extremely stable

Rot-free

No maintenance costs



..... With internal reinforcement

■ Grey ■ Brown



DIMENSIONS

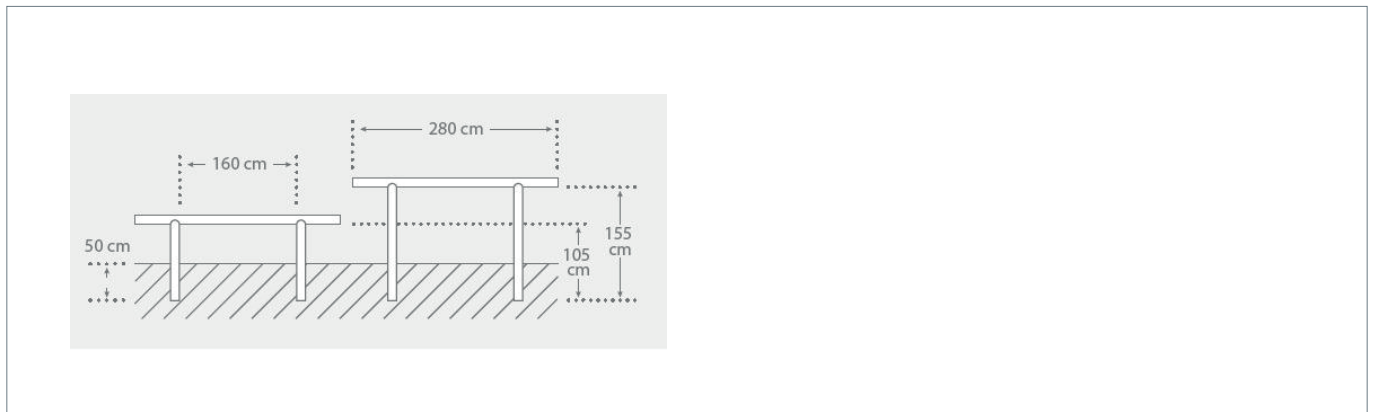

TECHNICAL DATA

Complete kit (2 x post, 1 x crossbar, Ø 12 cm)

| Height cm | Length cm | Weight kg | Colour | Order No | |
|--|-----------|-----------|--------|-------------|-------|
| 55,0 ¹ 105,0 ² | 280,0 | 52,0 | Grey | ABG 120 280 | |
| | | | Brown | ABB 120 280 | |
| 105,0 ¹ 55,0 ² | 280,0 | 64,0 | Grey | ACG 120 280 | 82,82 |
| | | | Brown | ACB 120 280 | 86,86 |

¹ Height after installation ² Total height

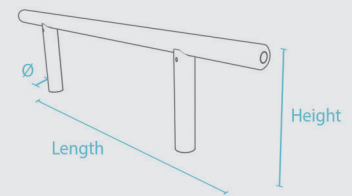

FURTHER DOCUMENTS PLEASE SEE WWW.HANIT.DE

- » Assembly Instruction
- » General Material Remarks
- » Tender Specifications
- » General Processing Guidelines





hanit® HANDRAIL SYSTEM

Support provided by flexible protection system

The hanit® handrail system is equally simple – just vertical posts and reinforced cross-members. These two elements can be combined for countless purposes using the threaded connectors included in the set. Perfect for safe crossings or for bordering access routes.

Material:

hanit® Recycled Plastics

Post dimensions:

12 x 150 cm

Cross bar dimensions:

12 x 250 cm and 12 x 280 cm

Version:

Cross bar with internal steel reinforcement

Openings will be closed with stoppers

Cross bars bevelled on both sides

Posts bevelled on upper edge

Advantages:

Flexible during mounting

Slight direction changes possible

No restriction on amount of crossbars

Rot-free

Extremely sturdy



■ Grey

■ Brown



www.blauer-engel.de/uz30a

MADE IN
GERMANY

HAHN
KUNSTSTOFFE

DRAWING

Cross-bar reinforcement:
 Material: Steel tubing, zinc-coated, S235
 Diameter: approx. 42.4 mm
 Wall thickness: approx. 2.5 mm



TECHNICAL DATA

Cross-bar round Ø 12 cm, reinforced

| Colour | Length (cm) | Weight (approx. kg) | Order No | Qty/Pal |
|---------|-------------|---------------------|-------------|---------|
| ■ Grey | 250.0 | 29.0 | PGE 120 250 | 28 |
| ■ Grey | 280.0 | 32.6 | PGE 120 280 | 28 |
| ■ Brown | 250.0 | 29.0 | PBE 120 250 | 28 |
| ■ Brown | 280.0 | 32.6 | PBE 120 280 | 28 |

Support post round Ø 12 cm

| Colour | Length (cm) | Weight (approx. kg) | Order No | Qty/Pal |
|---------|-------------|---------------------|------------|---------|
| ■ Grey | 150.0 | 15.8 | PG 120 150 | 28 |
| ■ Brown | 150.0 | 15.8 | PB 120 150 | 28 |

Assembly kit for one cross-bar

| Colour | Weight (approx. kg) | Order No | Qty/Pal |
|--------|---------------------|----------|---------|
| ■ Grey | 1.0 | PSBM-1 | 0 |

Caution: Observe the respective regulations when used as handrails.

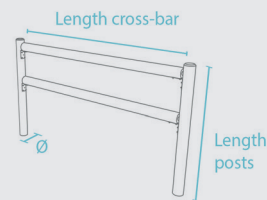

FURTHER DOCUMENTS PLEASE SEE WWW.HANIT.DE

- » General Material Remarks
- » General Processing Guidelines